

Differential pressure transmitter PASCAL CV Delta P

for diaphragm seal operation

Type series CV3330



Application area

- Chemical and petrochemical industry
- General process engineering
- Pharmaceutical industry
- General process technology

Application

The digital differential pressure transmitter PASCAL CV Delta P has been specially designed for the mounting of diaphragm seals with a volume reduced differential pressure chamber. Due to this design the transmitter is suitable for various applications, e.g. for the level measurement of pressure vessels.

Features

- Modulare differential pressure transmitter for diaphragm seal operation
- Various process connections with diaphragm seal technology (see product group D5)
- Wetted parts of stainless steel or special materials
- Function modules:
 - Multifunctional display with 5-segment digital display and bar graph
 - Switching module with 2 floating channels, maximum 0.5 A switching current, electrically isolated to all sides, without additional auxiliary power
 - with HART® module
- Function module replacement on site without recalibration, „plug and measure“
- Nominal ranges 0.4 up to 40 bar
- Turndown 5:1
- Accuracy $\leq 0.15\%$
- Output signal:
 - 4...20 mA
 - alternative with PROFIBUS PA
- Output functions: linear, invers, table function with up to 31 support points
- Stainless steel case in sturdy design, degree of protection IP 69K
- Media temperature -90...400 °C
- EAC declaration (upon request)

Options

- Approvals/Certificates
 - Explosion protection for gases and dust
 - Certificate of measuring equipment for Russian Federation
 - Material certificate as per EN 10204-3.1
 - Calibration certificate as per EN 10204-3.1
 - Classification per SIL2

PASCAL CV – the modular pressure transmitter

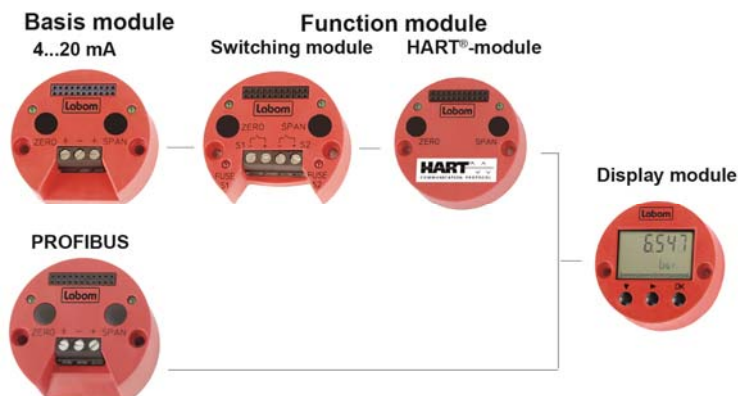

Technical data

Measuring ranges

Up to a turndown of 5:1 the measuring span can be freely selected.

Nominal range	Measuring span		Overload capacity		Static excess pressure both sides
	min. span	max. span	plus-side	minus-side	
-0.4...0.4 bar rel.	0.08 bar	0.8 bar	10 bar rel.	5 bar rel.	75 bar
-1...1 bar rel.	0.2 bar	2 bar	20 bar. rel.	10 bar rel.	75 bar
-1...4 bar rel.	0.8 bar	5 bar	50 bar rel.	25 bar rel.	75 bar
-1...16 bar rel.	3.2 bar	17 bar	100 bar rel.	75 bar rel.	100 bar
-1...40 bar rel.	8 bar	41 bar	100 bar rel.	75 bar rel.	100 bar

Minimum permissible static pressure: 30 mbar abs

Constructional design / case

Design:	Two-chamber case design with screw cap, continuously rotatable up to 170° Minimum case volume, excellent moisture and condensate protection
Material:	Stainless steel mat.-no. 1.4301 (304)
Degree of protection per EN 60529:	IP 69K
Climatic category per EN 60721 3-4:	4K4H
Window:	Non splintering plastic: Makrolon
Case seal:	O-ring: NBR
El. connection:	Screw terminal 1 mm ²
Cable gland:	<ul style="list-style-type: none"> ■ Cable gland M16, material: PA ■ Circular connector M12 Further details see order code and upon request.
Weight:	approx. 1.2 kg (with 1 m capillary)

Accuracy

Limit point setting:	per DIN 16086
Reference conditions:	per EN 60770-1
Linearity errors:	≤ 0.15 % of span TD 5:1 no modification
Hysteresis:	≤ 0.05 % of nominal range
Repeatability:	≤ 0.05 % of nominal range
Calibration position:	Vertical mounting position (display facing upwards)
Long-term drift: (EN 60770-1)	≤ 0.1 % / year of nominal range
Temperature influence of case:	Lower range value / upper range value Range 0...60 °C: ± 0.15 % / 10K of nominal range Range < 0 °C, > 60 °C: ± 0.2 % / 10K of nominal range
Influence static pressure:	Refer to nominal range
	0.4 bar 0.12 % x stat. pressure [bar] x TD
	1 bar 0.03 % x stat. pressure [bar] x TD
	4 bar 0.02 % x stat. pressure [bar] x TD
	16 bar 0.002 % x stat. pressure [bar] x TD
	40 bar 0.001 % x stat. pressure [bar] x TD

Process connection

Design:	Volume reduced differential pressure chamber, suitable for the direct mounting of diaphragm seals with capillary connection. Diaphragm seals see product group D5.
---------	---

Material wetted parts

Material:	see product group D5
-----------	----------------------

Measuring system

Sensor:	piezoresistive
System filling:	Due to the application there are different system fillings available, see Technical Instruction TA_031.

Output

<u>General:</u>	
Delay time:	approx. 160 ms
Measuring cycle:	6 measurements / second
Measuring range setting:	Turndown 5:1

Basic module: 4...20 mA

Signal:	4...20 mA, 2-wire
Current range:	3.8...20.8 mA
Current limitation:	approx. 22 mA
Alarm state:	< 3.6 mA, optional > 21 mA
Damping:	0...120 seconds
Load R:	$R \leq (U-12V \text{ DC})/0.022 \text{ A } [\Omega]$ U = supply voltage

Basic module: PROFIBUS PA

Signal:	digital per IEC 61158-2
Protocol:	EN 50170-PROFIBUS PA, Profile 3.0
Sensor address:	0...126 (126 = factory setting)
Power consumption:	constantly 11 mA
Alarm current I_{FDE} :	2 mA
Damping:	0...300 seconds
Parameterisation:	SIMATIC PDM

Supply voltage

Basic module:	<u>4...20 mA</u>	<u>PROFIBUS PA</u>
<u>Standard design:</u>		
Functional range:	12...40 V DC	9...32 V DC
<u>Ex-design:</u>		
Functional range:	12...30 V DC	9...17.5 V DC

Temperature ranges

Ambient:	-20...85 °C
Media:	-90...400 °C*
Storage:	-40...85 °C

* depending on the design of the diaphragm seal and the system filling

Tests and certificates

Interference emission:	per EN 55011
Noise immunity:	per EN 61326-1 *, NAMUR NE21 *

* Devices with cable gland or switching outputs might suffer from a short-time measuring deviation if exposed to strong electromagnetic fields (EN 61000-4-3).

Ex approvals:	TÜV 04 ATEX 2387 X ⊕ II 1/2G Ex ia IIC T4/T5/T6 Ga/Gb ⊕ II 2G Ex ia IIC T4/T5/T6 Gb ⊕ II 2D Ex ia IIIC Txx °C Db
---------------	---

For detailed Information see Ex Safety Instruction XA_015 and XA_020.

SIL2:	Functional safety per EN 61508, Classification per SIL2. For basic module 4...20 mA, switching module, display module and HART® module. For detailed information see manufacturer declaration HE_075.
-------	---

- EAC declaration upon request
- Certificate of measuring equipment for Russian Federation

Function modules

Display module (multifunctional display) optional

pluggable with automatic module detection - plug and measure -

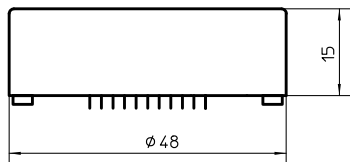
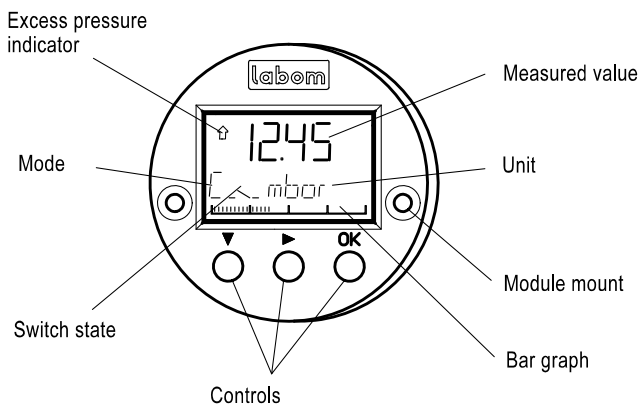

- Module housing made of ABS, encapsulated electronics unit
- Many operating mode menus
- 5-segment pressure read-out with unit
- Read-out display
 - pressure (standard)
 - percent *
 - current *
 - sensor temperature
- Bar graph 36 segment suitable 0...100 %
- Loop test (current sensing function) 3.55...22 mA *
- Alarm indicator on display
- Switching function indicator *

* not with basic module PROFIBUS PA

Details of the operator menu see parameterisation.

HART® module (for basic module 4...20 mA) optional

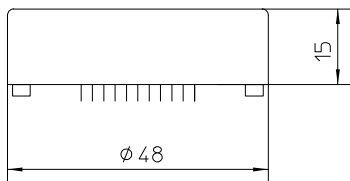
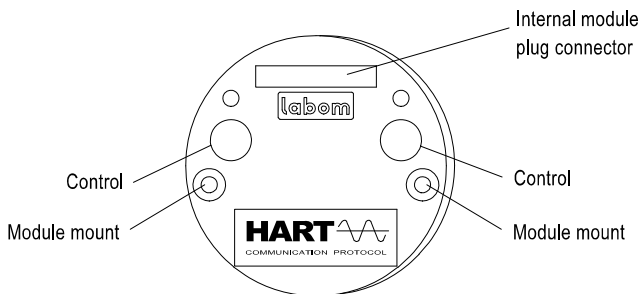

- HART®-protocol, revision 6.5
- Response characteristic FSK
- Load with HART® communication
 - with Hart® modem 230...500 Ω
 - with Hart® communicator 230...1100 Ω
- Parameterisation via
 - operating elements
 - HART® communication
- PDM 6.0
- AMS
- 375 Field Communicator

Switching module, (not with basic module PROFIBUS PA) optional

pluggable with automatic module detection - plug and measure -

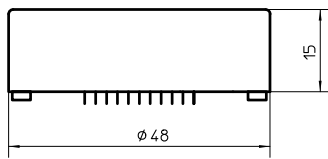
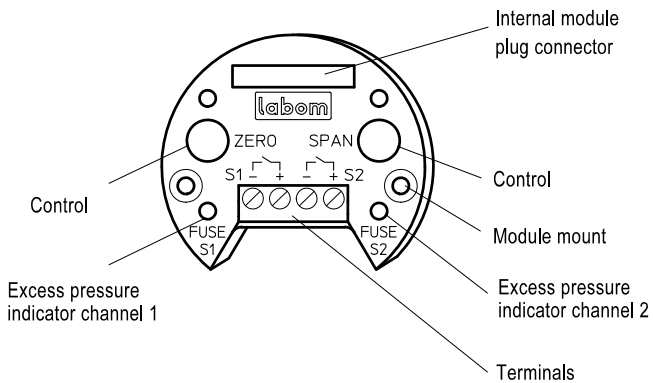

- No additional auxiliary power required
- Module housing made of ABS, encapsulated electronics unit
- Electronic switch for 2 limit values, voltage free, short-circuit-proof
- Switching capacity 30 V DC / 0.5 A ($R_i < 0.3 \Omega$)
- Indicator: red LED, indicates overload or short-circuit
- Cut-out fuse protects against overload / short-circuit with automatic reset
- Switch points: 0.0 - 100.0% adjustable, Standard: 50.0%
- Switching function: maker or breaker, adjustable, Standard: breaker
- Contact open when device switched off
- Hysteresis: 0.0...100 % adjustable, Standard 0.1 %
 - falling or rising, adjustable, standard: falling
- Switching rate: 6 Hz
- Electrically isolated to all sides, Insulation voltage: 500 V, 2.5 kV/2 sec.
- Electrical connection: terminal blocks 1 mm²

Hysteresis functions

-falling hysteresis-

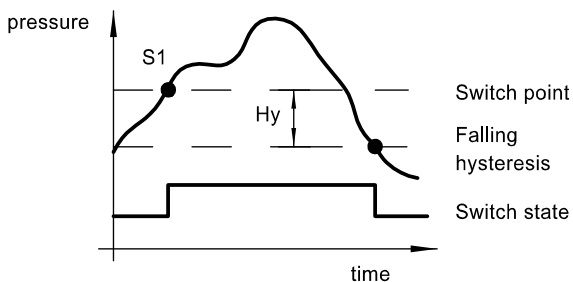

-rising hysteresis-

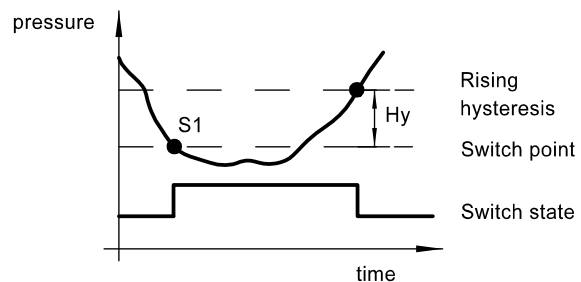

Description of switching module and HART® module upon request.

Parameterisation

The module selected determines which parameters can be set

operating menus	display of display module	parameter		basic module: 4...20 mA				basic module: PROFIBUS PA		
		variability	standard	BM	SM	AM	HM PDM AMS 475	BM	AM	PDM
zero point *	RANGE/Zero	see instrument ranges	0 bar	x	x	x	x	-	-	x
measuring span *	RANGE/Span	see instrument ranges	nominal range	x	x	x	x	-	-	x
damping	DAMP	4...20 mA: 0...120 sec. Profibus: 0...300 sec.	0 sec.	w	-	x	x	-	-	x
min-max-value	HI/LO	pressure and temperature reset-table	-	-	-	x	x	-	x	x
characteristic	FUNC	linear, table	linear	w	-	x	x	-	-	x
pressure unit	UNIT	bar, mbar, kPa, MPa, mmH2O, mH2O, kg/cm2, PSI	bar	w	-	x	x	-	w	x
loop test	LOOP	3.55...22 mA	-	-	-	x	x	-	-	-
alarm state	ALARM	< 3.6 mA, > 21 mA	< 3.6 mA	w	-	x	x	-	-	-
current trimming	I-CAL	-2...5 %	-	-	-	x	x	-	-	-
pressure trimming	P-CAL	zero point: -50...50 % v.N span: -10...10 % v.N	-	-	-	x	x	x	x	x
table function	TABLE	2...31 points of table	0% = 4 mA 100% = 20 mA	w	-	x	x	-	-	-
system info	INFO	software, serial number, revision level	-	-	-	x	x	-	x	x
factory data reset	RESET	-	-	-	-	x	x	-	x	x
BUS address	BUS	0...126	126	-	-	-	-	w	x	x
switch points	SWCH1(2)	0...100 % of nominal range	50 %	-	x	x	x	-	-	-
hysteresis	SWCH1(2)/Hyst.	0...100 % of nominal range	0,1 % hyster. falling	-	w	x	x	-	-	-
switch function	SWCH1(2)/SwTyp	breaker, maker	breaker	-	w	x	x	-	-	-
HART® address	HART/Adres	0...63	0	-	-	x	x	-	-	-
HART® current	HART/CUrr	fixed/float	float	-	-	x	x	-	-	-
write protection	-	ON/OFF	OFF	x	x	x	x	x	x	x

x = configurable

w = factor setting

* = calibrated measuring span for devices with PROFIBUS PA basic module

DM = display module

BM = basic module

SM = switching module

HM = HART-module

PDM = Siemens Process Device Manager

AMS = Asset Management Solutions

475 = Emerson Handheld Communicator

Connection diagram

Basic module: 4...20mA / PROFIBUS PA

Internal terminals with cable gland design

Circular connector ¹

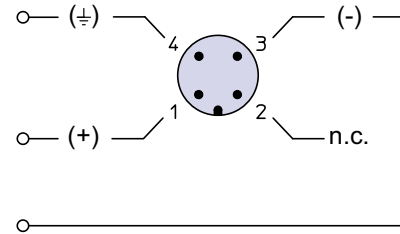
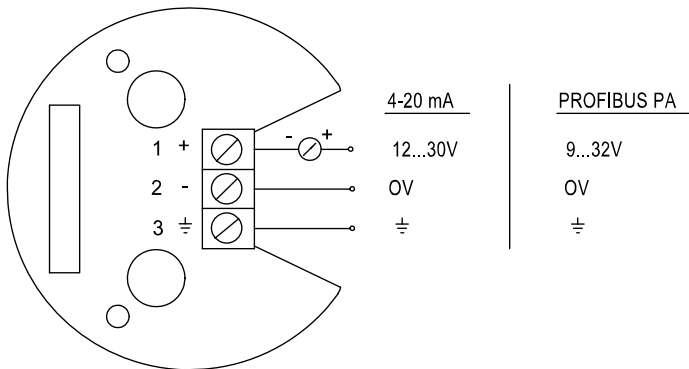

Switching module: (only with basic module 4...20 mA)

Circular connector ¹

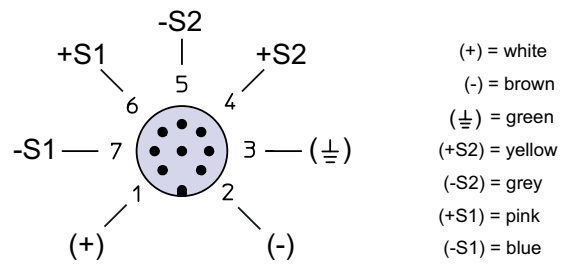
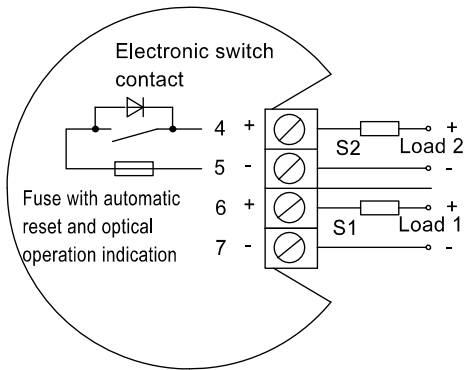

¹ color code as Binder series 763

Dimensions

Case

Dimensions/versions

housing design type 17

- basic module: 4...20 mA
- with one function modul (optional)
- basic module: PROFIBUS PA

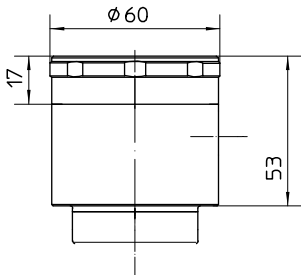

housing design type 25

- basic module: PROFIBUS PA
- with display module (optional)

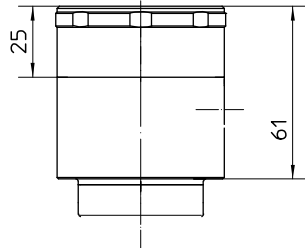

housing design type 32

- basic module: 4...20 mA
- with two function modules (optional)

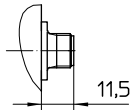
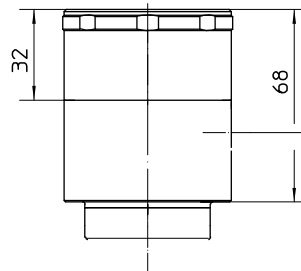

for circular connector
M12x1; 4 pol./8 pol.
for 4...20 mA/PROFIBUS PA

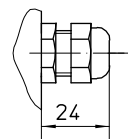

cable gland
M16x1,5 for cable ϕ 4,5-10

Case and process connections

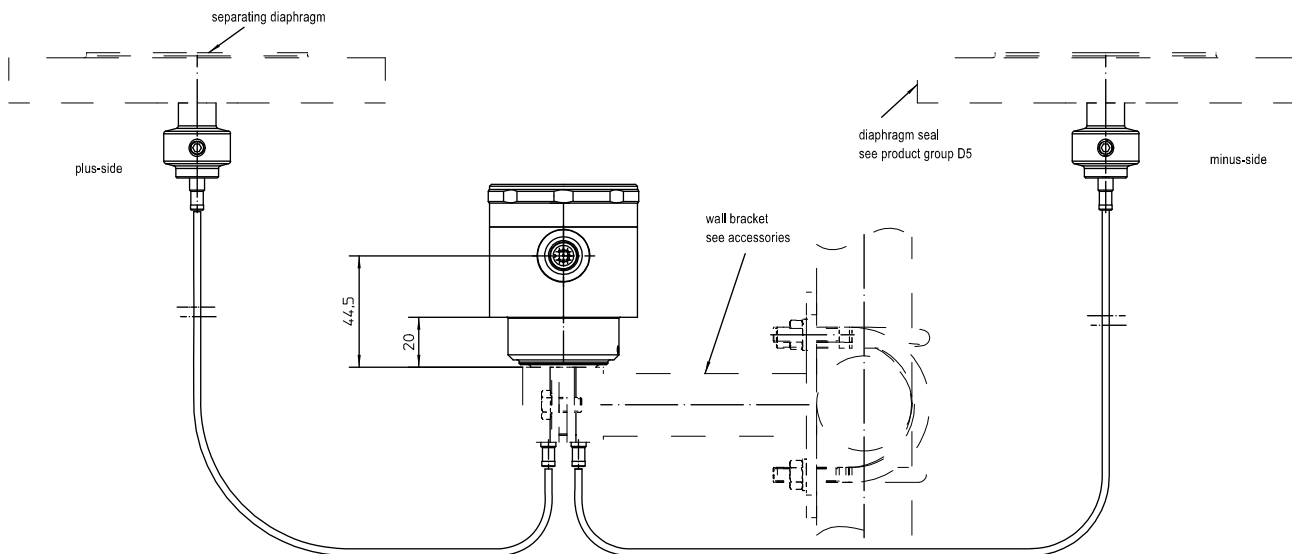

Wall bracket for wall and pipe mounting (Type series MM1110)

drilling diagram for tube ϕ 35-50

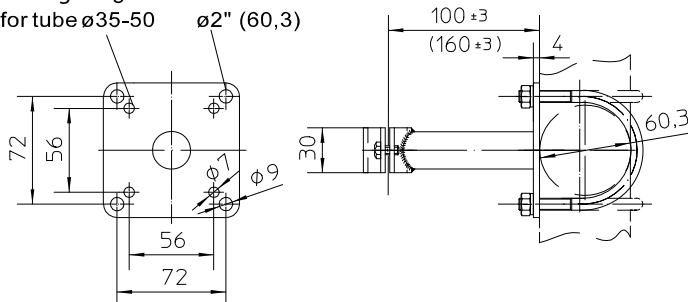

All dimensions are in mm

Order details

Differential pressure transmitter PASCAL CV Delta P for diaphragm seal operation Type series CV3330

Order details PASCAL CV Delta P CV3330				
CV3330	Pressure transmitter PASCAL CV Delta P for diaphragm seal operation			
A1051	nominal range	-0.4...0.4 bar		
A1053		-1...1 bar		
A1056		-1...4 bar		
A1059		-1...16 bar		
A1061		-1...40 bar		
F10	measuring range	0 to nominal range, unit: bar (standard)		
F11		0 to nominal range, unit: mbar		
F22		0 to nominal range, unit: kPa		
F23		0 to nominal range, unit: MPa		
F30		0 to nominal range, unit: mmH2O		
F32		0 to nominal range, unit: mH2O		
F41		0 to nominal range, unit: kg/cm ²		
F50		0 to nominal range, unit: PSI		
F80		set from... to... unit (please fill in details) not with PROIBUS PA		
F81		adjusted and calibrated from to, unit (please fill in details), see below for calibration report		
H11	output signal	4...20 mA, rising characteristic (standard)		
H15		20...4 mA, falling characteristic		
H21		4...20 mA with HART® function module, HART® protocol rev. 6		
0		setting ¹	damping	0.0 sec. (standard)
1				0.0...120 sec., set to (please fill in details)
0			alarm state	< 3.6 mA (standard)
1				> 21 mA
H41		Profibus PA, IEC 61158-2, Profil 3.0		
M1		display module	without	
M2			multifunctional display with 5-position digital display and bar graph, pluggable	
N10	switching module ^{2,3}	without switching module		
N5.		switching module with 2 contacts, pluggable, switching capacity 30 V DC / 0.5 A		
0		setting ¹	standard	
1			factory setting, specify as required	
T30	electrical connection	circular connector	M12x1 (4 pin)	
T31			M12x1 (8 pin, required for switching module)	
T20		cable gland M16x1,5	polyamide black	
T21			brass nickel-plated	
T22			stainless steel	
Process connections (diaphragm seals) see product group D5				

Additional features (to be indicated if required)		
S68	Ex-marking ²	⊕ II 2G Ex ia IIC T4/T5/T6 Gb, ⊕ II 2D Ex ia IIIC Txx°C Db
S66		⊕ II 1/2G Ex ia IIC T4/T5/T6 Ga/Gb
Z61	PROFIBUS PA	factory setting, please specify
Z62		measuring point number/identification max. 32 characters, please specify
Z63		measuring point text max. 32 characters, please specify
W1020	material certificate	per EN 10204-3.1, wetted part
W1201	calibration certificate	per EN 10204-3.1, 5 measuring point
W2602	functional safety per EN 61508, classification per SIL2 ³	
W2673	certificate of measuring equipment for Russian Federation ⁴	

Accessories		
MM1110	Device bracket per DIN 16281, model A, for wall and pipe-mounting, stainless steel mat.no. 1.4571 (316Ti)	
A10	design	for wall mounting
A11		for pipe diameter 35-50 mm
A12		for pipe diameter 2" (60.3 mm)
MC1020	HART®-modem for	RS 232-interface
MC1040		USB-interface
MC1041		USB-interface, Ex

Order detail (example): CV3330 – A1056 – F10 – H1100 – M2 – N10 – T30 - ...

¹ settings see parameterisation

² Ex-design not possible with switching module

³ not with PROFIBUS PA

⁴ not for devices with Ex-protection